

Vista posteriore

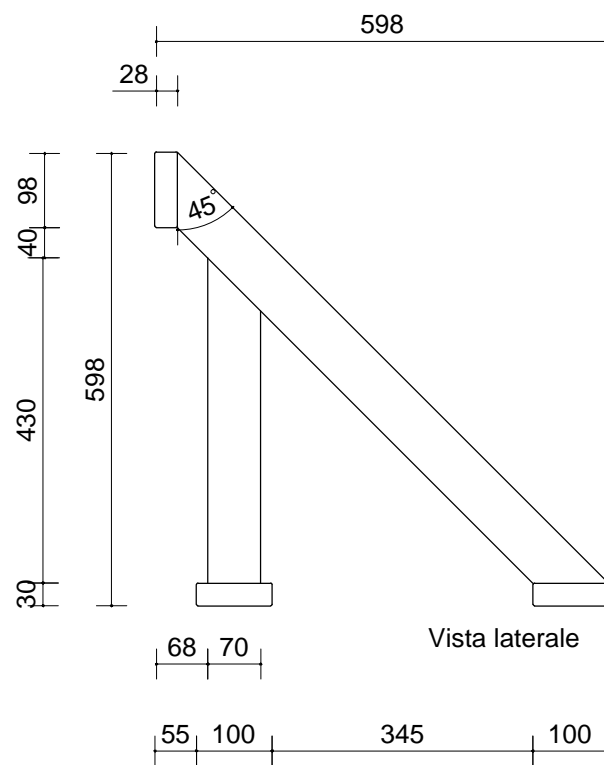

Vista laterale

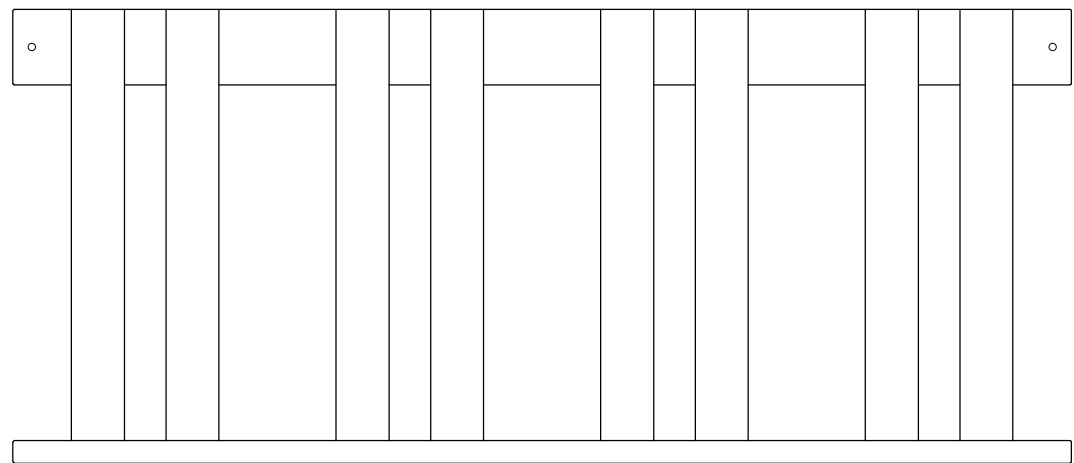

Vista frontale

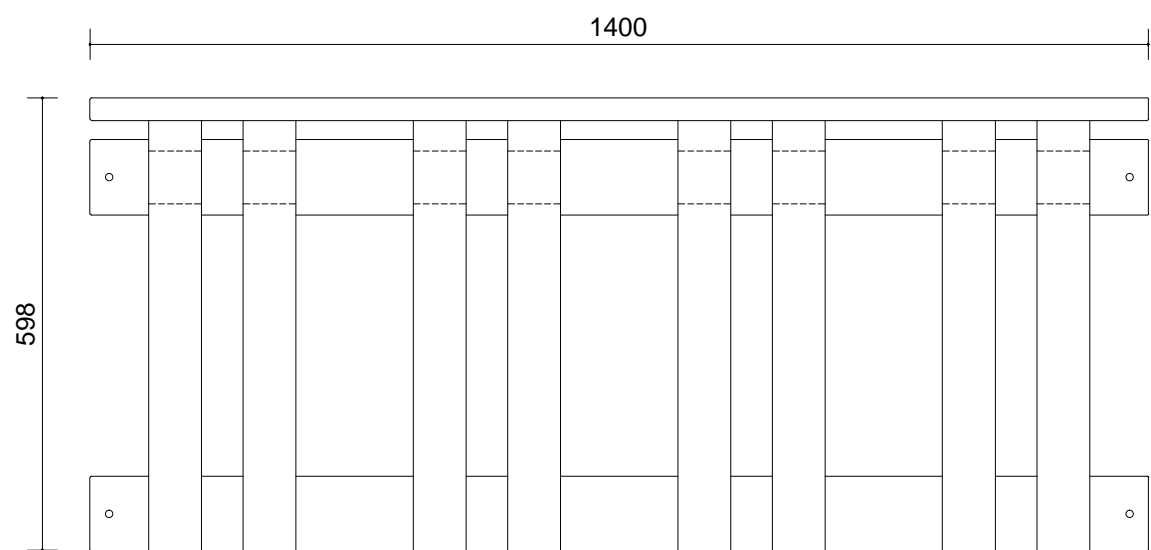

Vista dall'alto

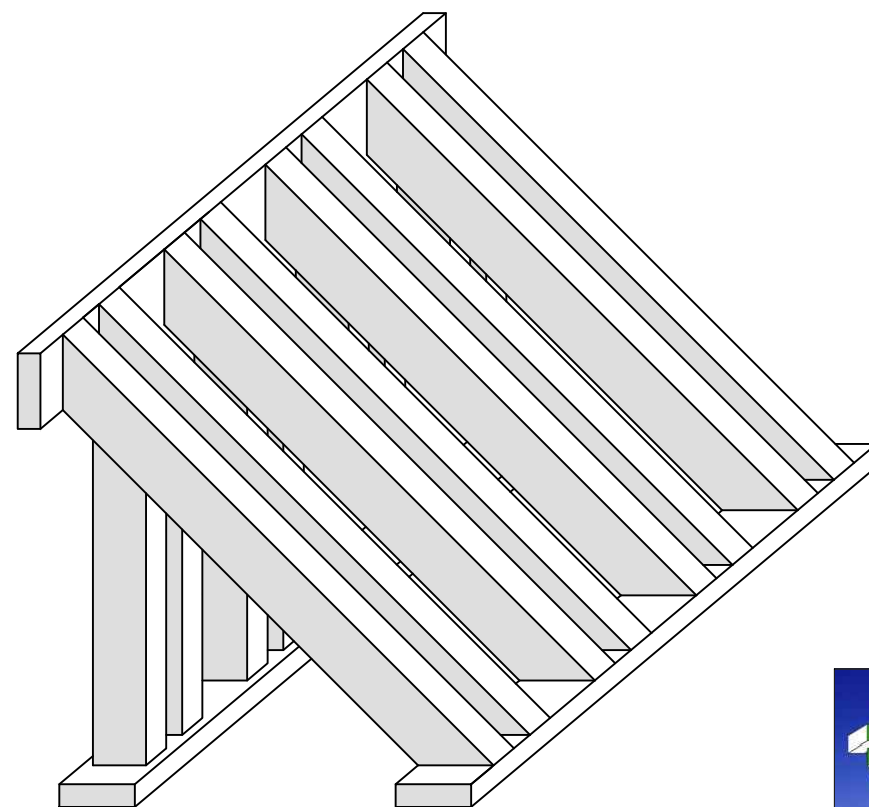

Assonometria Cavaliera

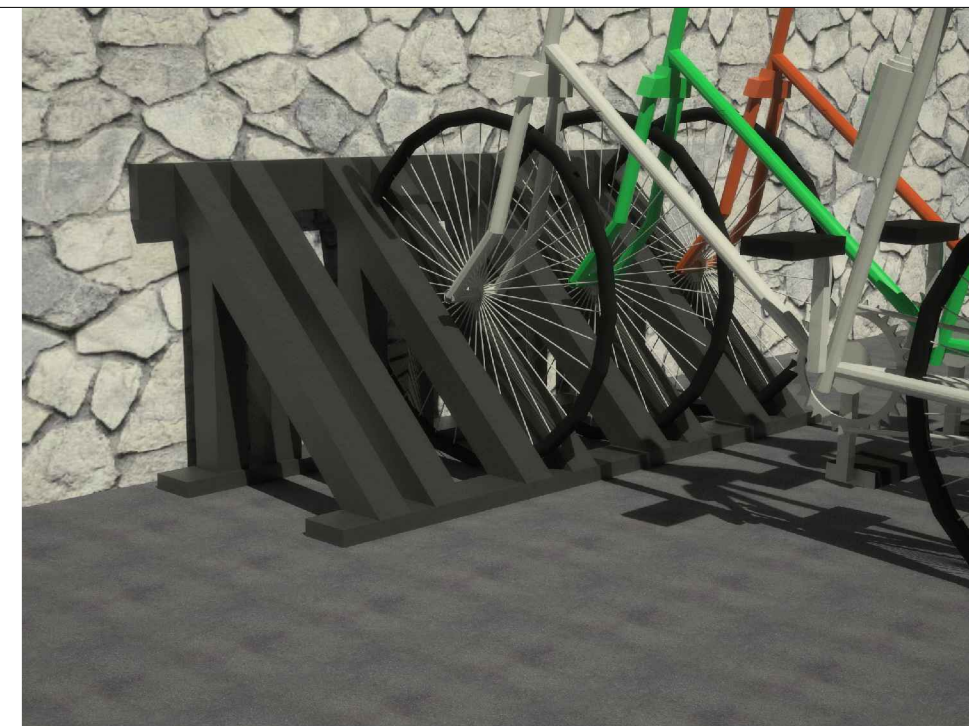

Render

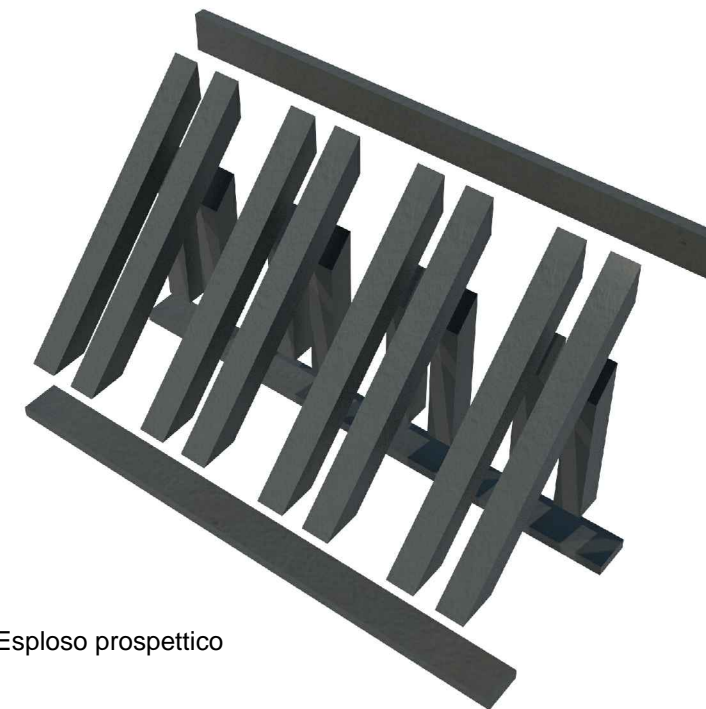

Esploso prospettico

		PRECO SYSTEM S.r.l. Via Facini 35 33013 - Gemona Del Friuli / Udine / Italy Tel.: +39.0432.970597 Fax: +39.0432.972456 e-mail: info@precosrl.com			DATA DI EMISSIONE Emission date 01/08/2011	
TOLLERANZE GENERALI Tolerance \pm		FOGLIO Sheet 1/3	REVISIONE Revision 00	PESO Weight 52,51 kg	NOME DISEGNO Filename Portabici4.dwg	
PROIEZIONE Projection 		CODICE/DESCRIZIONE Code/Title PORTABICI4 VISTE PRINCIPALI				
FORMATO DI STAMPA Printer format A3		CATEGORIA Category PORTABICI ARREDI				
E' VIETATO L'UTILIZZO DI QUESTO DISEGNO SENZA LA NOSTRA AUTORIZZAZIONE						

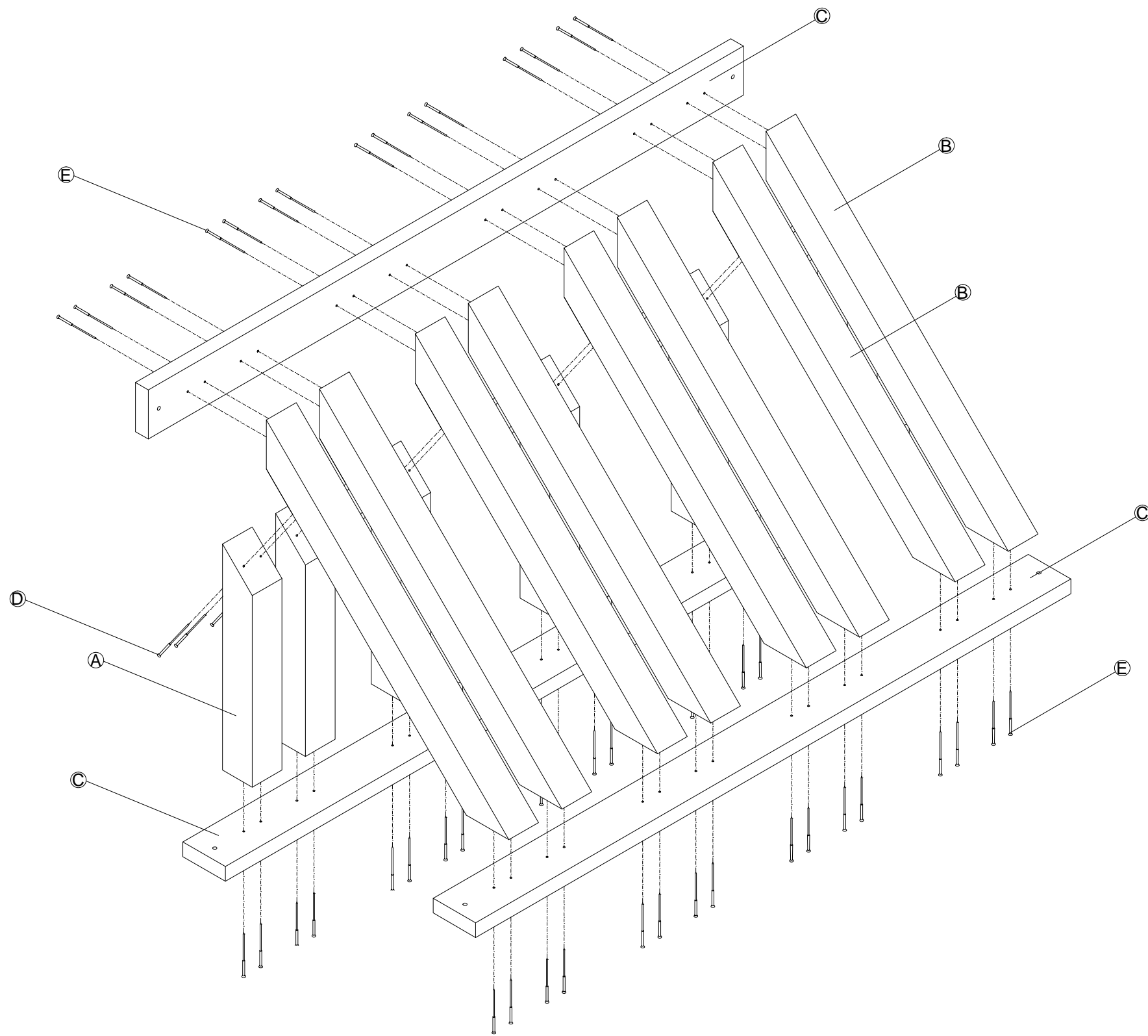

ESPLOSO ISOMETRICO

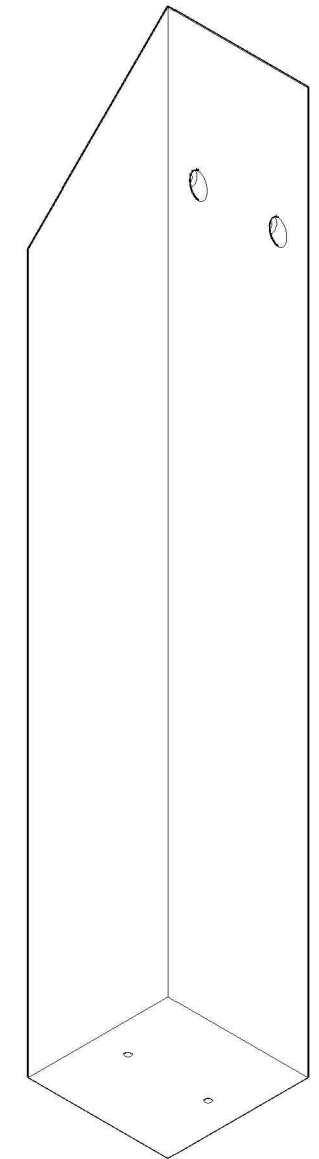

ASS.ISOMETRICA
COMPONENTE A

n. No	Q.ta' Q.ty	COMPONENTE Component	DIMENSIONI (mm) Dimensions (mm)	MATERIALE (Note) Materials (Notes)
A	8	MONTANTE	70x70x430	PSV
B	8	DIAGONALE	70x70x806,1	PSV
C	3	TRAVERSO LONGITUDINALE	30x100x1400	PSV
D	16	VITE PER TRUCIOLARE TSP	D5 x 70	ZINCATO BIANCO
E	48	VITE PER TRUCIOLARE TSP	D5 x 50	ZINCATO BIANCO
F	6	FISCHER TESTA TORX ANTIFURTO	10X100 WT IS	NYLON-ACCIAIO

		PRECO SYSTEM S.r.l. Via Facini 35 33013 - Gemona Del Friuli / Udine / Italy Tel.: +39.0432.970597 Fax: +39.0432.972456 e-mail: info@precosrl.com		DATA DI EMISSIONE Emission date: 01/08/2011 DISEGNATO Drawn By: Asquini Riccardo NUMERO DI TELEFONO Telephone number: Partita iva: E-Mail:	
SCALA Scale: 1:10	TOLLERANZE GENERALI Tolerance: ±1 mm	FOGLIO Sheet: 3/3	REVISIONE Revision: 00	PESO Weight: 52,51 kg	NOME DISEGNO Filename: Portabici4.dwg
PROIEZIONE Projection:		CODICE/DESCRIZIONE Code/Title: PORTABICI4 DETTAGLI COSTRUTTIVI			
FORMATO DI STAMPA Printer format: A3		CATEGORIA Category: PORTABICI ARREDI			

Nota: il fissaggio alla parete e al suolo avviene tramite il componente F, effettuando dei prefori d10mm in loco.

E' VIETATO L'UTILIZZO DI QUESTO DISEGNO SENZA LA NOSTRA AUTORIZZAZIONE